



MODEL RPT103
Cooling System Pressure Tester



MODEL MPT100CG
Coolant Guard and Pressure Tester
**CHANGE A COMPONENT WITH-
OUT DRAINING THE SYSTEM.**

COOLING SYSTEM REFILLERS:



MODEL MCR103A
For use with positive fit adapters

MODEL MCR103U
No Adapters Necessary!

MODEL APC102
SHOP AIR POWERED
COOLING SYSTEM
PRESSURE TESTER

(Pump available
separately,
part number
MPT5001-1)



MCR303T

Cooling System Refiller for Large Trucks



- New vacuum generator creates higher vacuum more quickly
- Enlarged passages & valves help to move coolant faster.
- Longer hose accommodates height of trucks
- Larger diameter hose increases fluid transfer speed
- Faster, more complete fill

See page 20
(back cover)
for parts diagram

MPT8001:

8 Piece Cooling System Adapter Set for Large Truck

This updated set includes the following adapters:

(back row, left to right) **MPT10084P**, **MPT10025P**, **MPT0010**, **MPT10027P**
(front row, left to right) **A4505B**, **MPT10058P**, **MPT10054P**, **TA50**.

MPT10084P is used to test 2015 and later Kenworth trucks, models T270 and T370.

MPT10025P is used on some Volvo trucks with a 45mm x 3mm threaded filler neck.

MPT0010 is used to test some 2007 and later Freightliner, Kenworth and Peterbilt trucks. **MPT10027P** is used to test Volvo trucks with a 63mm x 3mm threaded filler neck.

A4505B is used to test trucks with a "B" size 2 11/16" OD filler neck.

MPT10058P is used to test the Sprinter Van (Mercedes/Freightliner/Dodge).

MPT10054P is used to test Freightliners with a 60mm x 3mm threaded filler neck. **TA50** is used to test Volvo and Mack trucks with a 48mm x 3mm threaded filler neck.



Plastic case available separately #OSMPT8001PB

MPT17000:

An excellent display case including all adapters necessary for testing passenger vehicle cooling systems through 2015. Designed for the Matco Distributor. Includes 17 adapters in a plastic display case containing: MPT10128, MPT10138, MPT0022, MPT0025, MPT0031, MPT0034, MPT0036, MPT0041, MPT0044, MPT0046, MPT0048, MPT0052, MPT0056, MPT0245, MPT0345, MPT0445, A4503B.

Plastic case available separately as part #OSMPT17000PB

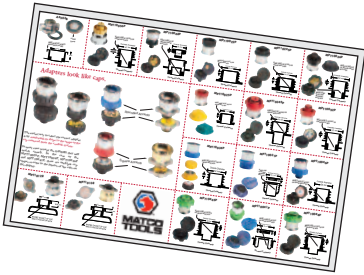

← **Laminated adapter application sheet included with both the MPT17000 and MTP14000P.**

- FITS RIGHT INSIDE THE CASE -

MPT14000P:

Designed as an add-on for the RPT101/RPT102. Carrying case comes with 14 composite cooling system adapters. When added to the RPT101/RPT102 with its pump and 3 adapters, the combination will pressure test the cooling systems of all modern cars and light trucks through 2015.

Pump and adapters fit into the case as shown on the right. Includes the following 14 adapters:

MPT10022P, MPT10025P,
MPT10031P, MPT10034P,
MPT10041P, MPT10044P,
MPT10046P, MPT10048P,
MPT10052P, MPT10056P,
MPT10245P, MPT10345P,
MPT10445P, and A4503B.

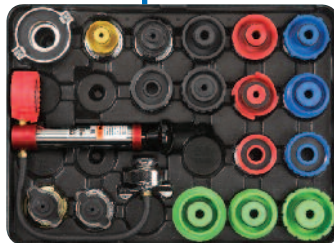

Matco's RPT102 shown stored within the MPT14000P

Note: Plastic case available separately as Part # OSMPT17000PB

MPT1C035P



MPT0010



WHERE GASKET OF CAP SEALS ON COOLANT BOTTLE NECK

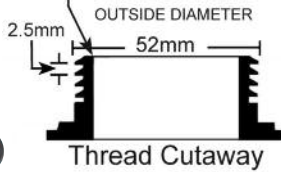

Thread Cutaway

APPLICATION:

Some models of Buick, Cadillac, Chevrolet, Ford, Freightliner, GMC, International, Infiniti, Isuzu, Jaguar, Kenworth, Land Rover, Lincoln, Mazda, Mercedes, Mercury, Nissan, Oldsmobile, Peterbilt and Pontiac.

MPT0022



MPT10022P



WHERE GASKET OF CAP SEALS ON COOLANT BOTTLE NECK

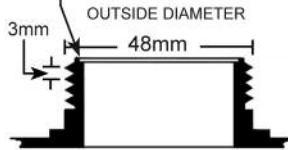

Thread Cutaway

APPLICATION:

AUDI: models with male threads on filler neck
PORSCHE:
Boxster: 1997-2006
Cayman: 2006
911: 1999-current
SMART CAR:
All Models: 2008-current
VOLKSWAGEN: models with male threads on filler neck of radiator or expansion tank

MPT0025



MPT1C026P



MPT10025P



WHERE GASKET OF CAP SEALS ON COOLANT BOTTLE NECK

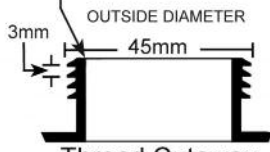

Thread Cutaway

APPLICATION:

FERRARI/MASERATI:
most models 2000-current
JEEP: models with male threads on filler neck (1990-1994)
RENAULT: (1985-1997)
SAAB 900: (1978-1993)
-900 Convertible (1994)
-9000 (1986-1998)
STERLING: (1987-1991)
VOLVO: most models with threaded filler neck through 2008 (see page 17)

MPT0031



MPT10031P



WHERE O-RING OF CAP SEALS ON COOLANT BOTTLE NECK

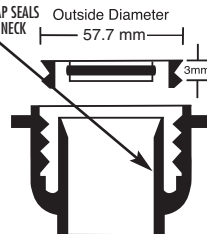

Thread Cutaway

APPLICATION:

VOLKSWAGEN:
models with female threads on filler neck 1990-1998

MPT0034



MPT10034P



WHERE GASKET OF CAP SEALS ON COOLANT BOTTLE NECK

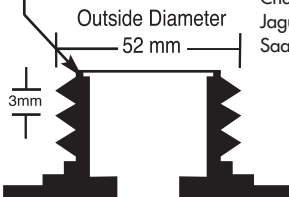

Thread Cutaway

APPLICATION:

Some models of Cadillac, Chevrolet, Daewoo, Ford, Jaguar, Land Rover, Pontiac, Saab, Saturn and Suzuki

MPT1C047P



MPT10036P



MPT0036

MPT1C035P



WHERE O-RING OF CAP SEALS ON COOLANT BOTTLE NECK

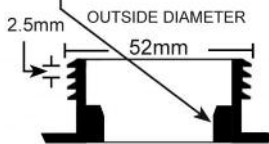

Thread Cutaway

APPLICATION:

Some models of Buick, Cadillac, Chevrolet, Ford, Freightliner, GMC, Hummer, International, Infiniti, Isuzu, Jaguar, Land Rover, Lincoln, Mazda, Mercedes, Mercury, Nissan, Pontiac, Saab, Saturn and Suzuki.

MPT10041P



MPT1C040P



MPT0041

WHERE O-RING OF CAP SEALS ON COOLANT BOTTLE NECK

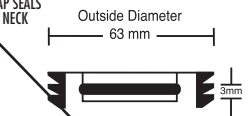

Thread Cutaway

APPLICATION:

AUDI: Most models with female threads on filler neck 2000-current

BENTLEY: 2006-current

LAMBORGHINI: 2006-current

PORSCHE:

Boxster 2007-2013

Cayenne 2003-2013

Cayman 2007-2011

Macan 2015-current

Panamera 2010-current

VW: Most Models 1998 & newer

MPT1C045P



MPT0044



MPT10044P



WHERE O-RING OF CAP SEALS ON COOLANT BOTTLE NECK

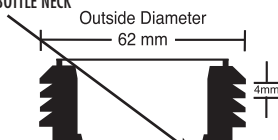

Thread Cutaway

APPLICATION:

MERCEDES-BENZ:

with threaded filler neck on expansion tank (except M-class, 1998-2005)

(see page 15)

CHRYSLER:

Crossfire 2004-2008

MPT1C047P



MPT0046



MPT10046P



WHERE O-RING OF CAP SEALS ON COOLANT BOTTLE NECK

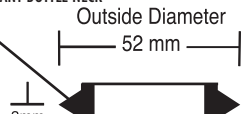

3mm

APPLICATION:

Some models of Aston Martin, Ford, Jaguar and Mazda.

MPT1C049P



MPT0048



MPT10048P



WHERE O-RING OF CAP SEALS ON COOLANT BOTTLE NECK

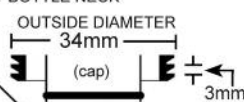

Thread Cutaway

APPLICATION:

LEXUS:

LS 2007-current

TOYOTA:

Celica 2000-2005

Spyder (MR2) 2000-2005

Rav 4 2009-current

Hybrid Synergy Drive

Cooling System:

Prius 2004-current

Camry 2007-current

Highlander 2006-current

SCION:

XB, 2008-2015

MPT0052



MPT1C053P



MPT10052P

WHERE O-RING OF CAP SEALS ON COOLANT BOTTLE NECK

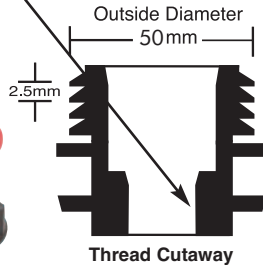

APPLICATION:

ASTON MARTIN

6.0 L, V-12 2015-current

FORD:

Escape 2013-current
F-150 2015-current
Fiesta 2011-current
Focus 2012-current
Fusion 2013-current
Mustang V-8 2015-current

LAND ROVER:

LR-2 2008-current
Range Rover
Evoque 2012-current

MAZDA:

Mazda 3 2004-current

VOLVO:

Most Models 2004-current

MPT0056



MPT1C057P

MPT10056P



WHERE GASKET OF CAP SEALS ON COOLANT BOTTLE NECK

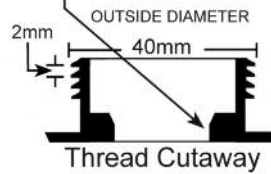

APPLICATION:

CHEVROLET:

Cobalt SS 2005-2007
(Supercharger
Cooling System)
Volt 2012: (Battery &
Electric Motor)

SATURN:

Ion Redline 2004-2007
(Supercharger
Cooling System)

CADILLAC:

STS, CTS, ATS 2006-2010
(Supercharger
Cooling System)

MPT0058



MPT1C059P

MPT10058P



WHERE O-RING OF CAP SEALS ON COOLANT BOTTLE NECK

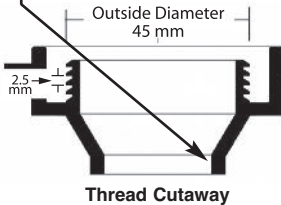

APPLICATION:

DODGE:

Sprinter Van 2007-2010

FREIGHTLINER

Sprinter Van 2008-current

MERCEDES

Sprinter Van 2011-current



MPT0060

WHERE GASKET OF CAP MEETS RADIATOR NECK

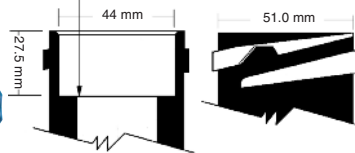

APPLICATION:

PORSCHE:

Boxster: 2006-2012

Caymen: 2006-2012

(Non-pressure relieving cap
located in luggage
compartment of vehicle).

MPT0063



PAGE 6

MPT10063P



MPT1C026P

WHERE O-RING OF CAP SEALS ON COOLANT BOTTLE NECK

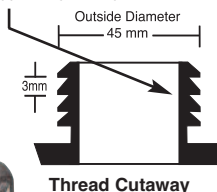

APPLICATION:

BMW:

Turbocharger Cooling
Systems (all)

MINI:

Cooper 2002-current

Comment: The MPT0063 and MPT10063P seal with an o-ring just like the cap from the system they test. In most cases the MPT0025 and MPT10025P, which seal on the top rim will adequately seal such that pressure testing can be accomplished.

**KTM
MOTORCYCLES
BAYONET STYLE
ADAPTER**



MPT10067



MPT10067R

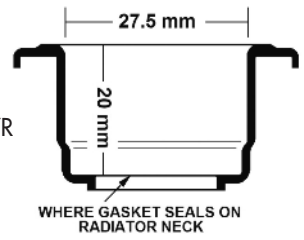

**KTM
MOTORCYCLES
THREADED
ADAPTER**



MPT10069P

WHERE GASKET OF CAP SEALS ON RADIATOR NECK

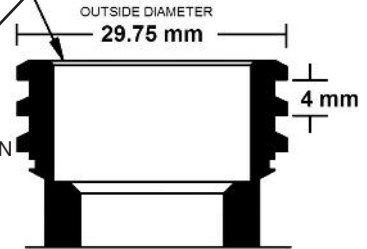

**APRILIA
MOTORCYCLES
THREADED
ADAPTER**



MPT10070P

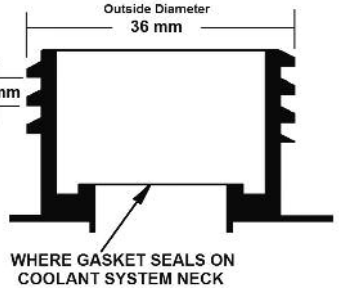

MPT10072P



MPT1C026P



WHERE GASKET OF CAP SEALS ON COOLANT BOTTLE NECK

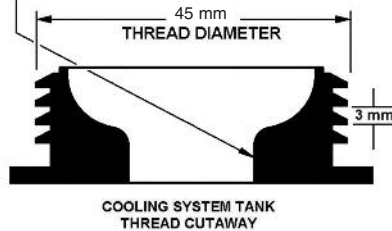

Comment: The MPT10072P seals with an o-ring just like the cap from the system it tests. In most cases, the MPT0025 and MPT10025P, which seal on the top rim will adequately seal such that pressure testing can be accomplished.

APPLICATION:
ALFA ROMEO:
Some models with threaded filler necks
FERRARI:
2015-current
FIAT:
Model 500: Some versions with threaded filler necks
DODGE:
ProMaster
MASERATI:
Ghibli S Q4
2015-current



MPT10074P

WHERE O-RING OF CAP SEALS ON COOLANT BOTTLE NECK

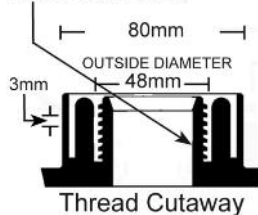

APPLICATION:
BENTLEY
Some Models
VOLKSWAGEN
Sharan (EU)
Phaeton 2004-2006 (US)



MPT10078P



WHERE O-RING OF CAP SEALS ON COOLANT BOTTLE NECK

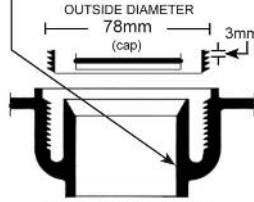

Thread Cutaway

APPLICATION:

PORSCHE
Boxster 2015-current
Cayman 2014-current
(Found in luggage compartment)



MPT1C087P

MPT10086P



WHERE GASKET OF CAP SEALS ON COOLANT BOTTLE NECK



Thread Cutaway

APPLICATION:

HYUNDAI
Tucson 2016-current
KIA
Sportage 2016-current

MPT0092



MPT10092P

"Image Coming Soon!"



NOTE: THIS ADAPTER HAS LEFT-HANDED THREAD

WHERE O-RING OF CAP SEALS ON COOLANT BOTTLE NECK

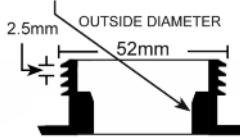

Thread Cutaway

APPLICATION:

CHEVROLET DURAMAX
Engine 2017-current

MPT0245



MPT1C047P



MPT10245P



WHERE GASKET OF CAP SEALS ON COOLANT BOTTLE NECK

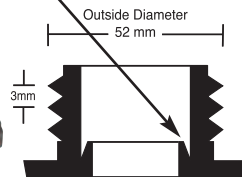

Thread Cutaway

APPLICATION:

BMW: models with threaded filler necks (up to 1987)
325: up to 1991
525: up to 1993
MERKUR SCORPIO: (1987-1989)

Comments:
Rubber gasket seals on "shelf" inside expansion tank neck

MPTC246



MPT1C346P



MPT0345

MPT10345P



WHERE GASKET OF CAP SEALS ON COOLANT BOTTLE NECK

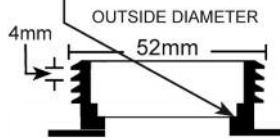

Thread Cutaway

APPLICATION:

BMW:
most models 1988-2008
LAND ROVER:
Some models with male threads on filler neck (see page 15)
Discovery 1999-2004
Range Rover 1996-2006

Comments:
Rubber gasket seals on "shelf" inside expansion tank neck

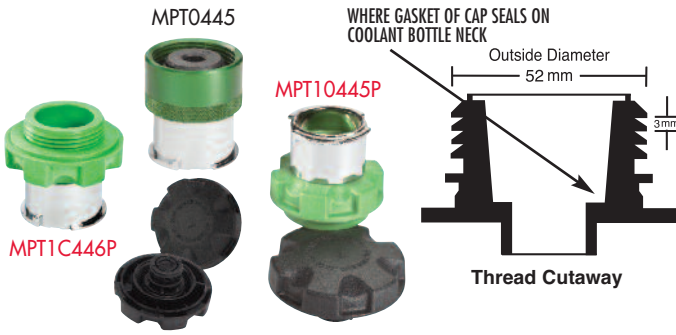

APPLICATION:

BMW:
 (most models, 2007-current)
 3-Series 2006-current
 5-Series 2005-current
 6-Series 2005-current
 X3 2009-current
 X5 2009-current
 X6 2008-current

FORKLIFTS - MOTORCYCLES - TOYOTA SIENNA VAN

Remote adapter allows pressure pump or vacuum refiller to be installed in various low overhead applications.



MPT0007R

Most motorcycles, including the Harley Davidson liquid cooled models, use this configuration



MPTC007



MPTC008



Comments: The MPTC007/MPT0007/MPT10128 and the MPTC008/MPT0008/MPT10138 have applications too numerous to list here. See Application Guide pp 12-17. These adapter sets are quite similar, but the MPTC007/MPT0007/MPT10128 is a deeper neck than the MPTC008/MPT0008/MPT10138. See drawings above, right.

Note: MPT10128 & MPT10138 are shaped to resemble caps from the system to be tested.

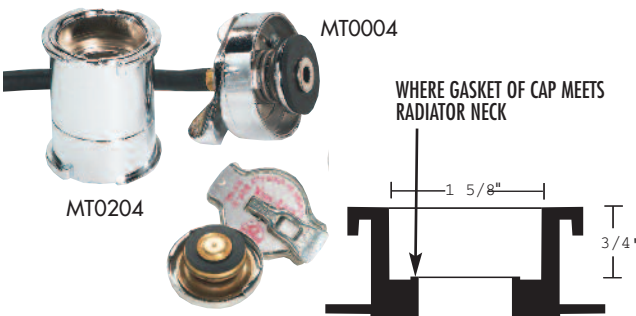

APPLICATION:

Most passenger vehicles through the mid 1980's have this radiator neck and many still do today. This is the configuration onto which the pump attaches directly.

For Necks 1" deep use 1/4" thick MT0006 spacer washer to compensate.

LARGE TRUCKS / BUSES / HEAVY EQUIPMENT



WHERE GASKET OF CAP SEALS ON COOLANT BOTTLE NECK

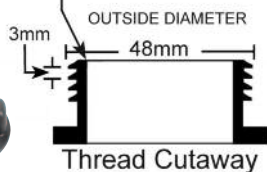

APPLICATION:

MACK TRUCKS:

2008 and later with 48mm x 3mm threads on filler neck

VOLVO:

Large Trucks with 48mm x 3mm male thread on filler neck

MPT0027



MPT10027P



WHERE GASKET OF CAP SEALS ON COOLANT BOTTLE NECK

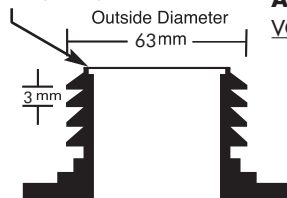

APPLICATION:

VOLVO:

Large Trucks with 63mm x 3mm thread on filler neck



MPT0054

MPT10054P



WHERE GASKET OF CAP SEALS ON COOLANT BOTTLE NECK

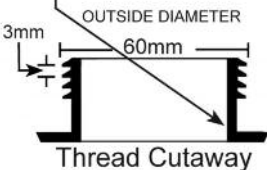

APPLICATION:

FREIGHTLINER:

Trucks with 60mm x 3mm male thread on filler neck

LARGE TRUCKS / BUSES / HEAVY EQUIPMENT / INDUSTRIAL



MPT10076

Note: Cap and adapter have 3 tabs

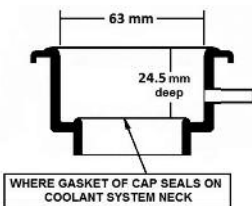

APPLICATION:
LIEBHERR CRANE:
Some models
VAN HOOL BUS:
Some models



MPT10084P



WHERE GASKET OF CAP SEALS ON COOLANT BOTTLE NECK

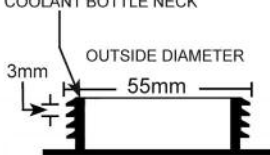

Thread Cutaway

APPLICATION:
KENWORTH:
2015-current
T270
T370



MPT0090

Note:
Cap and adapter have 3 tabs



WHERE GASKET OF CAP SEALS ON COOLANT BOTTLE NECK

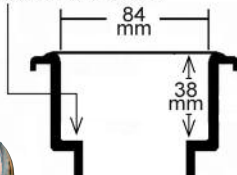

Thread Cutaway

APPLICATION:
INDUSTRIAL
APPLICATIONS:
With a 84mm neck

A4504B
(Cap Adapter Only)



MPT0450
(Two Adapter Set)



A4505B
(Cooling System Adapter Only)

MPT0450
Type cap

PART #MPT0450:

Truck adapter kit for trucks with "B" size 2 11/16" O.D. filler neck

WHERE GASKET OF CAP MEETS RADIATOR NECK (A4503B)

WHERE GASKET OF CAP MEETS RADIATOR NECK (A4505B)

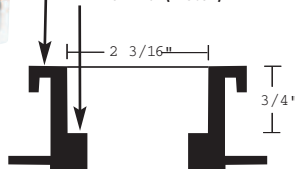

A4503B

A4503B
Type cap

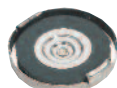

PART #A4503B: GM adapter kit tests pressure on "closed cooling systems" on GM 2.5L "X" body cars and 1.8L "J" body cars

All non-stocking adapters are available through Matco special order. Use "OS" prefix when ordering.

COOLING SYSTEM ADAPTERS

Make/Model/Year	Cooling System Adapter	Cap Adapter
ACURA		
Models with 16mm deep filler neck, see page 9	MPT0007/MPT10128	MPTC007
Models with 9.5mm deep filler neck, see page 9	MPT0008/MPT10138	MPTC008
ALFA ROMEO		
4C		
2014-current	MPT10072P*	MPT1C026P
Giulia	MPT10072P*	MPT1C026P
2016-current	MPT10072P*	MPT1C026P
Giulietta	MPT10072P*	MPT1C026P
2014-current	MPT10072P*	MPT1C026P
Mito	MPT10072P*	MPT1C026P
2014-current	MPT10072P*	MPT1C026P
ASTON MARTIN		
6.0 L V-12		
2015-current	MPT0052/MPT10052P	MPT1C053P
Various Models		
2005-current	MPT0046/MPT10046P	MPT1C047P
Vantage V-8		
2013-current	MPT0046/MPT10046P	MPT1C047P
AUDI		
Models with male threads on filler neck of exp. tank		
	MPT0022/MPT10022P	MPTC023/MPT1C023P
Models with female threads on filler neck of exp. tank		
	MPT0041/MPT10041P	MPTC040/MPT1C040P
BLUEBIRD BUS		
Late model Thomas		
Built buses	MPT0036/MPT10036P	MPTC037/MPT1C035P
BMW		
Most models with threaded filler neck		
Up to 1987	MPT0245/MPT10245P	MPTC246/MPT1C047P
1988-2008	MPT0345/MPT10345P	MPTC346/MPT1C346P
2009-current	MPT0445/MPT10445P	MPTC446/MPT1C446P
Model 325		
1988-1991	MPT0245/MPT10245P	MPTC246/MPT1C047P
Model 535		
1989-1993	MPT0245/MPT10245P	MPTC246/MPT1C047P
1 Series		
2008-current	MPT0445/MPT10445P	MPTC446/MPT1C446P
3 Series		
1990-2006	MPT0345/MPT10345P	MPTC346/MPT1C346P
2006-current	MPT0445/MPT10445P	MPTC446/MPT1C446P
5 Series		
1989-2004	MPT0345/MPT10345P	MPTC346/MPT1C346P
2005-current	MPT0445/MPT10445P	MPTC446/MPT1C446P
Turbocharger Cooling Sys (all)		
	MPT0063/MPT10063P▲	MPT1C026P
6 Series		
2004-current	MPT0445/MPT10445P	MPTC446/MPT1C446P
Turbocharger Cooling Sys (all)		
	MPT0063/MPT10063P▲	MPT1C026P
7 Series		
1994-2008	MPT0345/MPT10345P	MPTC346/MPT1C346P
2008-current	MPT0445/MPT10445P	MPTC446/MPT1C446P
Turbocharger Cooling Sys (all)		
	MPT0063/MPT10063P▲	MPT1C026P
X1		
2009-2011	MPT0345/MPT10345P	MPTC346/MPT1C346P
X3		
2004 - 7/2009-	MPT0345/MPT10345P	MPTC346/MPT1C346P
7/2009-current	MPT0445/MPT10445P	MPTC446/MPT1C446P

Make/Model/Year	Cooling System Adapter	Cap Adapter
BMW		
X5		
2000-2008	MPT0345/MPT10345P	MPTC346/MPT1C346P
2009-current	MPT0445/MPT10445P	MPTC446/MPT1C446P
Turbocharger Cooling Sys (all)		
	MPT0063/MPT10063P▲	MPT1C026P
X6		
2008-current	MPT0445/MPT10445P	MPTC446/MPT1C446P
Turbocharger Cooling Sys (all)		
	MPT0063/MPT10063P▲	MPT1C026P
Z3		
2002	MPT0345/MPT10345P	MPTC346/MPT1C346P
Z4		
2003-2008	MPT0345/MPT10345P	MPTC346/MPT1C346P
2009-current	MPT0445/MPT10445P	MPTC446/MPT1C446P
Z8		
2003	MPT0345/MPT10345P	MPTC346/MPT1C346P
BUICK		
All Models w/male threads on filler neck except as noted below		
	MPT0036/MPT10036P	MPTC037/MPT1C035P
Roadmaster		
1994-1996	MPT0036/MPT10036P**	MPTC010/MPT1C035P
Skyhawk		
1982-1987 1.8L & 2.0L	A4503B	
Skylark		
1982-1988 2.5L	A4503B	
1992-1998	MPT0036/MPT10036P**	MPTC010/MPT1C035P
Somerset		
1985-1987 2.5L	A4503B	
CADILLAC		
All Models w/male threads on filler neck except as noted below		
	MPT0036/MPT10036P	MPTC037/MPT1C035P
Catera		
1997- 2001	MPT0034/MPT10034P	MPTC246/MPT1C047P
Fleetwood		
1994-1996	MPT0036/MPT10036P**	MPTC010/MPT1C035P
Seville		
1998-2004	MPT0036/MPT10036P**	MPTC037/MPT1C035P
STS, CTS, ATS		
2005-2010	MPT0036/MPT10036P	MPTC037/MPT1C035P
Engine Cooling System		
Supercharger Cooling System	MPT0056/MPT10056P	MPTC057
CHEVROLET		
All Models w/ male threads on filler neck except as noted below		
	MPT0036/MPT10036P	MPTC037/MPT1C035P
Aveo		
2004-2011	MPT0034/MPT10034P	MPTC246/MPT1C047P
Bereita		
1992-1996	MPT0010/MPT10036P**	MPTC010/MPT1C035P
Caprice		
1994-1996	MPT0010/MPT10036P**	MPTC010/MPT1C035P
Cavalier		
1995-1998	MPT0010/MPT10036P**	MPTC010/MPT1C035P

*MPT0025/MPT10025P may also work.

▲ MPT0063/MPT10063P seals the same way the radiator cap seals but the MPT0025/MPT10025P will work in most applications.

**If MPT0036/MPT10036 "Stem" with O-ring does not fit, MPT0010 may be required.

All non-stocking adapters are available through Matco special order. Use "OS" prefix when ordering.
COOLING SYSTEM ADAPTERS

Make/Model/Year	Cooling System Adapter	Cap Adapter
CHEVROLET - CONTINUED		
Citation 1982-1985 2.5L	A45038	
Cobalt 2005-2010		
Engine Cooling System	MPT0036/MPT10036P	MPTC037/MPT1C035P
Supercharger Cooling System	MPT0056/MPT10056P	MPTC057/MPT1C057P
Corsica 1992-1996	MPT0036/MPT10036P**	MPTC010/MPT1C035P
Duramax (LSP diesel) engine 2017-current	MPT0092/MPT10092P▲	
2017-current	MPT0036/MPT10036P▲▲	MPT1C035P
Impala 1994-1996	MPT0036/MPT10036P**	MPTC010/MPT1C035P
2004-current	MPT0036/MPT10036P	MPTC037/MPT1C035P
Lumina 1990-1992	A45038	
Malibu 1997-1998	MPT0010/MPT10036P**	MPTC010/MPT1C035P
1999-current	MPT0036/MPT10036P	MPTC037/MPT1C035P
Metro 1998-2001	MPT0008/MPT10138	MPTC008
Nova 1985-1988	MPT0007/MPT10128	MPTC007
Prizm 1998-2002	MPT0008/MPT10138	MPTC008
Spectrum 1985-1989	MPT0007/MPT10128	MPTC007
Sprint 1985-1988	MPT0007/MPT10128	MPTC007
Tracker 1998-2004	MPT0008/MPT10138	MPTC008
Volt 2012-current		
Electric Motor	MPT0056/MPT10056P	MPTC057/MPT1C057P
Battery System	MPT0056/MPT10056P	MPTC057/MPT1C057P
Gasoline Engine	MPT0036/MPT10036P	MPTC037/MPT1C035P
CHRYSLER/DODGE/EAGLE/PLYMOUTH		
200 2015-current	MPT0036/MPT10036P	MPTC037/MPT1C035P
2000GTX 1989-90	MPT0007/MPT10128	MPTC007
Avenger 1995-1999	MPT0007/MPT10128	MPTC007
Colt 1984-1993	MPT0007/MPT10128	MPTC007
1992-1994 (some models)	MPT0008/MPT10138	MPTC008
Conquest 1984-1989	MPT0007/MPT10128	MPTC007
Crossfire 2004-2008	MPT0044/MPT10044P	MPTC045/MPT1C045P
Dart 2013-2016	MPT0036/MPT10036P	MPTC037/MPT1C035P
Laser/Talon 1990-1998	MPT0007/MPT10128	MPTC007
Pacifica 2017-current	MPT0036/MPT10036P	MPT1C037P
Promaster 2014-current	MPT10072P*	MPT1C026P
RAM 50 Pickup 1987-1993	MPT0007/MPT10128	MPTC007
Ram Series Pick-up 2013-(6cyl., Diesel)	MPT0036/MPT10036P	MPTC037/MPT1C035P
Sebring 2003-2005 6c 3.0L & 4c 2.4L	MPT0008/MPT10138	MPTC008
2001,2002,2006-	none	MTO204

Make/Model/Year	Cooling System Adapter	Cap Adapter
CHRYSLER/DODGE/EAGLE/PLYMOUTH		
Sprinter Van 2007-2010	MPT0058/MPT10058P	MPTC059
Stealth 1991-1996	MPT0007/MPT10128	MPTC007
Stratus (3.0 liter only) 2001-2006	MPT0008/MPT10138	MPTC008
Summit 1989-1992	MPT0007/MPT10128	MPTC007
1992-1996	MPT0008/MPT10138	MPTC008
Talon 1990-1998	MPT0007/MPT10128	MPTC007
DAEWOO		
All 1999-2002	MPT0034/MPT10034P	MPTC246/MPT1C047P
FERRARI		
Most Models 2000-current	MPT0025/MPT10025P	MPTC026/MPT1C026P
FIAT		
500 2015-current	MPT10072*	MPT1C026P
FORD/LINCOLN/MERCURY		
All Models w/male threads on filler neck except as noted below	MPT0036/MPT10036P**	MPTC010/MPT1C035P
Aspire 1994-1997	MPT0007/MPT10128	MPTC007
C-Max 2013-current	MPT0052/MPT10052P	MPTC053/MPT1C053P
Contour/Mystique 1995-1997	MPT0034/MPT10034P	MPTC246/MPT1C047P
1998-2000	MPT0046/MPT10046P	MPTC047/MPT1C047P
Cougar 1989-1992	MPT0007/MPT10128	MPTC007
1993-1997 V6	MPT0007/MPT10128	MPTC007
1993-1997 V8	MPT0036/MPT10036P**	MPTC010/MPT1C035P
Edge 2015-current	MPT0052/MPT10052P	MPTC053/MPT1C053P
Escape 2001-2012	MPT0046/MPT10046P	MPTC047/MPT1C047P
2013-current	MPT0052/MPT10052P	MPTC053/MPT1C053P
Escort/Tracer 1991-2012	MPT0007/MPT10128	MPTC007
Explorer/Mountaineer/Aviator 1995-2002	MPT0007/MPT10128	MPTC007
2002-current	MPT0036/MPT10036P**	MPTC010/MPT1C035P
F-150 Pickup 2015-current	MPT0052/MPT10052P	MPTC053/MPT1C053P
Festiva 1988-1993	MPT0007/MPT10128	MPTC007
Fiesta 2011-current	MPT0052/MPT10052P	MPTC053/MPT1C053P
Focus 2000-2004	MPT0034/MPT10034P	MPTC246/MPT1C047P
2005-2007	MPT0036/MPT10036P**	MPTC010/MPT1C035P
2008-2011	MPT0007/MPT10128	MPTC007
2012-current	MPT0052/MPT10052P	MPTC053/MPT1C053P
Fusion/MKZ 2013-current	MPT0052/MPT10052P	MPTC053/MPT1C053P
LS 2002-2006	MPT0034/MPT10034P	MPTC246/MPT1C047P
MKC 2015-current	MPT0052/MPT10052P	MPTC053/MPT1C053P

*MPT0025/MPT10025P may also work.

**If MPT0036/MPT10036 "Stem" with O-ring does not fit, MPT0010 may be required.

▲ Non pressure relieving ▲▲ Pressure relieving

All non-stocking adapters are available through Matco special order. Use "OS" prefix when ordering.

COOLING SYSTEM ADAPTERS

Make/Model/Year	Cooling System Adapter	Cap Adapter
FORD/LINCOLN/MERCURY - CONTINUED		
Mustang V8, 1996-current	MPT0036/MPT10036P**	MPTC010/MPT1C035P
V6, 1997-2004	MPT0007/MPT10128	MPTC007
V6, 2005-current	MPT0036/MPT10036P**	MPTC010/MPT1C035P
V8, 2015-current	MPT0052/MPT10052P	MPTC053/MPT1C053P
Probe 1989-1997	MPT0007/MPT10128	MPTC007
Ranger Pickup 1995-(non threaded neck) 2002-current	MPT0007/MPT10128 MPT0036/MPT10036P**	MPTC007 MPTC010/MPT1C035P
Super Duty Pick-up expansion tank 2012-current	MPT0036/MPT10036P**	MPTC037/MPT1C035P
Tempo/Topaz 1992-1994	MPT0007/MPT10128	MPTC007
Thunderbird 1989-1993 (All) 1994-1997 (V6) 1994-1997 (V8) 2002-2004 (V8)	MPT0007/MPT10128 MPT0007/MPT10128 MPT0036/MPT10036P** MPT0036/MPT10036P**	MPTC007 MPTC007 MPTC010/MPT1C035P MPTC010/MPT1C035P
Transit Connect 2010-2012 2013-current	MPT0034/MPT10034P MPT0052/MPT10052P	MPTC246/MPT1C047P MPTC053/MPT1C053P
Villager 1993-2002	MPT0007/MPT10128	MPTC007
Windstar 1995-2000 2000-2003	MPT0007/MPT10128 MPT00036/MPT10036P	MPTC007 MPTC010/MPT1C035P
ZX2 2001-2003	MPT0007/MPT10128	MPTC007
FREIGHTLINER		
Trucks with: 60mm x 3mm male thread 52mm x 2.5mm male thread 2007-Cascadia 2002-Century, Columbia	MPT0054/MPT10054P MPT0010 MPT0036/MPT10036P	MPTC010/MPT1C035P MPTC037/MPT1C035P
GEO		
Metro 1989-1994 1995-1998	MPT0007/MPT10128 MPT0008/MPT10138	MPTC007 MPTC008
Prizm 1989-1992 1993-2002	MPT0007/MPT10128 MPT0008/MPT10138	MPTC007 MPTC008
Storm 1990-1993	MPT0007/MPT10128	MPTC007
Tracker 1989-1993 1994-2004	MPT0007/MPT10128 MPT0008/MPT10138	MPTC007 MPTC008
GMC		
All Models with male threads on filler neck	MPT0036/MPT10036P	MPTC037/MPT1C035P
HONDA		
Models with 16mm deep filler neck, see page 9 Models with 9.5mm deep filler neck, see page 9	MPT0007/MPT10128 MPT0008/MPT10138	MPTC007 MPTC008

**If MPT0036/MPT10036 "Stem" with O-ring does not fit, MPT0010 may be required.

Make/Model/Year	Cooling System Adapter	Cap Adapter
HUMMER		
All models with male threads on filler neck	MPT0036/MPT10036P	MPTC037/MPT1C035P
HYUNDAI		
All models 1987-current Tucson 2016-current	MPT0007/MPT10128 MPT10086P	MPTC007 MPT1C087P
INDUSTRIAL		
Various industrial applications (see page 11 for specs)	MPT10090	
INTERNATIONAL		
466 Engine with male threads on filler neck 1994-1998	MPT0010	MPTC010/MPT1C035P
INFINITI		
All Models with Non-Threaded Small Cooling System Caps (see page 9) QX30 2017-current QX56 2004-2009 2010-current	MPT0007/MPT10128 MPT0044/MPT10044P MPT0036/MPT10036P** MPT007/MPT10128	MPTC007 MPT1C045P MPTC010/MPT1C035P MPTC007
ISUZU		
All models except as noted below 1985-2009	MPT0007/MPT10128	MPTC007
Amigo 1999-2000 (L-4 only)	MPT0008/MPT10138	MPTC008
Ascender 2002-2009 i280 2006 i290 2007-2008 i350 2006 i370 2007-2008 Oasis 1996-1999 Rodeo 1998-2003 (L-4 only)	MPT0036/MPT10036P MPT0036/MPT10036P MPT0036/MPT10036P MPT0036/MPT10036P MPT0036/MPT10036P MPT0036/MPT10036P MPT0008/MPT10138	MPTC037/MPT1C035P MPTC037/MPT1C035P MPTC037/MPT1C035P MPTC037/MPT1C035P MPTC037/MPT1C035P MPTC008
JAGUAR		
All Models with male threads on filler neck 1990-1994 F-Type 2013-current XE 2015-current XF 2009-current XJ 2009-current XJ8 1998-2003 2004-2009 XK8 1997-2004, 2006 S-Type 2002-2008 X-Type 2002-2009	MPT0034/MPT10034P MPT0036/MPT10036P** MPT0010 MPT0036/MPT10036P** MPT0010 MPT0046/MPT10046P MPT0036/MPT10036P** MPT0046/MPT10046P MPT0036/MPT10036P** MPT0034/MPT10034P	MPTC246/MPT1C047P MPTC037/MPT1C035P MPT1C035P MPTC037/MPT1C035P MPT1C035P MPTC047/MPT1C047P MPTC037/MPT1C035P MPTC047/MPT1C047P MPTC037/MPT1C035P MPTC047/MPT1C047P

All non-stocking adapters are available through Matco special order. Use "OS" prefix when ordering.
COOLING SYSTEM ADAPTERS

Make/Model/Year	Cooling System Adapter	Cap Adapter
JEEP		
Models with male threads on filler neck 1987-1990 Cherokee 2014-current Renegade 2015-current	MPT0025/MPT10025P MPT0036/MPT10036P MPT0036/MPT10036P	MPTC026/MPT1C026P MPTC037/MPT1C035P MPTC037/MPT1C035P
JOHN DEERE TRACTORS		
Most model #'s over 3000 with 48mm O.D. male threads on filler neck	MPT0022/MPT10022P	MPTC023/MPT1C023P
Most model #'s over 3000 with 52mm O.D. male threads on filler neck	N/A - consult factory	N/A
KENWORTH TRUCKS		
Some Models 2007-current T270, T370 2015-current	MPT0010 MPT10084P	MPTC010/MPT1C035P
KIA		
Models with 16mm deep filler neck, see page 9 Sportage 2016-current	MPT0007/MPT10128 MPT10086	MPTC007 MPT1C087P
LAND ROVER		
Defender 1993-1995, 1997 Discovery 1998 1999-2004 Freelander 2002-current LR2 2008-current LR3 2005-2009 LR4 2010-current Range Rover 1988-1994 1995-2005 2006-current Range Rover Evoque 2012-current	MPT0034/MPT10034P MPT0345/MPT10345P MPT0025/MPT10025P MPT0052/MPT10052P MPT0036/MPT10036P MPT0036/MPT10036P MPT0034/MPT10034P MPT0345/MPT10345P MPT0036/MPT10036P MPT0052/MPT10052P	MPTC246/MPT1C047P MPTC346/MPT1C346P MPTC026/MPT1C026P MPTC053/MPT1C053P MPTC010/MPT1C035P MPTC010/MPT1C035P MPTC246/MPT1C047P MPTC346/MPT1C346P MPTC010/MPT1C035P MPTC053/MPT1C053P
LEXUS		
Models with 16mm deep filler neck, see page 9 Models with 9.5mm deep filler neck, see page 9	MPT0007/MPT10128 MPT0008/MPT10138	MPTC007 MPTC008
GS 460 2008-current HS 250h 2010-current IS F 2008-current LS 2007-current NX200T 2015-current	MPT0048/MPT10048P MPT0048/MPT10048P MPT0048/MPT10048P MPT0048/MPT10048P MPT0048/MPT10048P MPT0048/MPT10048P	MPTC049/MPT1C049P MPTC049/MPT1C049P MPTC049/MPT1C049P MPTC049/MPT1C049P MPTC049/MPT1C049P

*MPT0025/MPT10025P may also work.

Make/Model/Year	Cooling System Adapter	Cap Adapter
LIEBHERR CRANE		
Some Models	MPT10076	
MACK TRUCK		
Late models with male threads on filler neck	TASO/MPT10022P	MPT1C023P
MASERATI		
Most Models 2000-current Ghibli S Q4 2015-current	MPT0025/MPT10025P MPT10072P*	MPTC026/MPT1C026P MPT1C026P
MAZDA		
Models with 16mm deep filler neck, see page 9	MPT0007/MPT10128	MPTC007
Models with 9.5mm deep filler neck, see page 9	MPT0008/MPT10138	MPTC008
Models with Threaded Caps: B 2300 Pickup 1994-1997 2001-2009 Tribute 2001-2011 Mazda 3 2004-current Mazda 6 2003-current	none MPT0036/MPT10036P MPT0046/MPT10046P MPT0052/MPT10052P MPT0036/MPT10036P	MT0204 MPTC037/MPT1C035P MPTC047/MPT1C047P MPTC053/MPT1C053P MPTC037/MPT1C035P
MERCEDES		
Models with threaded neck except as noted	MPT0044/MPT10044P	MPTC045/MPT1C045P
M-Class with threaded neck 1998-2005 M-Class 2006-current Sprinter Van 2011-current	MPT0036/MPT10036P MPT0044/MPT10044P MPT0058/MPT10058P	MPTC037/MPT1C035P MPTC045/MPT1C045P MPT0059/MPT1C059P
MERKUR		
Scorpio 1987-1989	MPT0245/MPT10245P	MPTC246/MPT1C047P
MINI		
Cooper S Model 2002-current	MPT0063/MPT10063P▲	MPT1C026P
MITSUBISHI		
Models with 16mm deep filler neck, see page 9	MPT0007/MPT10128	MPTC007
Models with 9.5mm deep filler neck, see page 9	MPT0008/MPT10138	MPTC008
NISSAN		
All models with non-threaded small cooling system caps 1987-current Armada/Titan 2004-2009 2010-current	MPT0007/MPT10128 MPT0036/MPT10036P MPT0007/MPT10128	MPTC007 MPTC010/MPT1C035P MPT1C007

**If MPT0036/MPT10036P "Stem" with O-ring does not fit, MPT0010 may be required.

▲MPT0063/MPT10063P seals the same way the radiator cap seals but the MPT0025/MPT10025P will work in most applications

All non-stocking adapters are available through Matco special order. Use "OS" prefix when ordering.

COOLING SYSTEM ADAPTERS

Make/Model/Year	Cooling System Adapter	Cap Adapter
OLDSMOBILE		
Achieva 1992-1998	MPT0036/MPT10036P**	MPTC010/MPT1C035P
Alero 1999-2004	MPT0036/MPT10036P	MPTC037/MPT1C035P
Aurora 1995-1999	MPT0036/MPT10036P**	MPTC010/MPT1C035P
Bravada 2002-2004	MPT0036/MPT10036P	MPTC037/MPT1C035P
Cutlass 1997-1998 1999	MPT0036/MPT10036P** MPT0036/MPT10036P	MPTC010/MPT1C035P MPTC037/MPT1C035P
Intrigue 1999 2000-2002	MPT0036/MPT10036P** MPT0036/MPT10036P	MPTC010/MPT1C035P MPTC037/MPT1C035P
PETERBILT TRUCKS		
Some Models 2007-current	MPT0010	MPTC010/MPT1C035P
PONTIAC		
Fiero 1984-1988	A4503B	
Firebird 1999-2002	MPT0036/MPT10036P	MPTC037/MPT1C035P
G3 2009-2010	MPT0034/MPT10034P	MPTC246/MPT1C047P
G5 2007-2010	MPT0036/MPT10036P	MPTC037/MPT1C035P
G6 2005-2010	MPT0036/MPT10036P	MPTC037/MPT1C035P
Grand Am 1985-1988 1992-1998 1999-2005	A4503B MPT0010/MPT10036P MPT0036/MPT10036P	MPTC010/MPT1C035P MPTC037/MPT1C035P
Grand Prix 2004-2008	MPT0036/MPT10036P	MPTC037/MPT1C035P
GTO 2004-2006	MPT0036/MPT10036P	MPTC037/MPT1C035P
Le Mans 1988-1993	MPT0034/MPT10034P	MPTC246/MPT1C047P
Montana 1999-2006 2007-2009	none MPT0036/MPT10036P	MT0204 MPTC037/MPT1C035P
Optima 1988-1991	MPT0036/MPT10036P	MPTC010/MPT1C035P
Solstice 2006-2009	MPT0036/MPT10036P	MPTC037/MPT1C035P
Sunbird 1982-1992	A4503B	
Sunburst 1985-1988	MPT0007/MPT10128	MPTC007
Sunfire 1995-1998 1999-2005	MPT0010/MPT10036P MPT0036/MPT10036P	MPTC010/MPT1C035P MPTC037/MPT1C035P
Vibe 2003-2010	MPT0008/MPT10138	MPTC008

**If MPT0036/MPT10036 "Stem" with O-ring does not fit, MPT0010 may be required.

Make/Model/Year	Cooling System Adapter	Cap Adapter
PORSCHE		
911 1999-current	MPT0022/MPT10022P	MPTC023/MPT1C023P
Boxster/Cayman (3 prong access cap) 2007-2013	MPT0060	
Boxster 1997-2006 2007-2013 2015-current (in luggage compartment)	MPT0022/MPT10022P MPT0041/MPT10041P MPT10078P	MPTC023/MPT1C023P MPTC040/MPT1C040P
Cayenne 2003-2013	MPT0041/MPT10041P	MPTC040/MPT1C040P
Cayman 2006 2007-2011 2014-current (in luggage compartment)	MPT0022/MPT10022P MPT0041/MPT10041P MPT10078P	MPTC023/MPT1C023P MPTC040/MPT1C040P
Macan 2015-current	MPT0041/MPT10041P	MPTC040/MPT1C040P
Panamera 2010-current	MPT0041/MPT10041P	MPTC040/MPT10041P
RENAULT		
All models 1985-1987	MPT0025/MPT10025P	MPTC026/MPT1C026P
SAAB		
900 1978-1993 1994-1998	MPT0025/MPT10025P MPT0034/MPT10034P	MPTC026/MPT1C026P MPTC246/MPT1C047P
900 Convertible 1994	MPT0025/MPT10025P	MPTC026/MPT1C026P
9000 1986-1998	MPT0025/MPT10025P	MPTC026/MPT1C026P
9-3 1999-2003 2004-2011	MPT0034/MPT10034P MPT0036/MPT10036P	MPTC246/MPT1C047P MPTC037/MPT1C035P
9-5 1999-2008	MPT0034/MPT10034P	MPTC246/MPT1C047P
9-7 X 2005-2009	MPT0036/MPT10036P	MPTC037/MPT1C035P
SATURN		
All models except as below 1990-1998 1999-2010	MPT0010/MPT10036P MPT0036/MPT10036P	MPTC010/MPT1C035P MPTC037/MPT1C035P
L-Series 2000-2005	MPT0034/MPT10034P	MPTC246/MPT1C047P
Vue 2002 2003-2009	MPT0034/MPT10034P MPT0036/MPT10036P	MPTC246/MPT1C047P MPTC037/MPT1C035P
Ion Redline 2004-2007 Engine Cooling System Supercharger Cooling System	MPT0036/MPT10036P MPT0056/MPT10056P	MPTC037/MPT1C035P MPTC057/MPT1C057P
SCION		
All models 2004-current	MPT0008/MPT10138	MPTC008
XB 2008-current	MPT0048/MPT10048P	MPTC049/MPT1C049P
SMART CAR		
All models 2008-current	MPT0022/MPT10022P	MPTC023/MPT1C023P

All non-stocking adapters are available through Matco special order. Use "OS" prefix when ordering.

COOLING SYSTEM ADAPTERS

Make/Model/Year	Cooling System Adapter	Cap Adapter
STERLING		
All models 1987-1991	MPT0025/MPT10025P	MPTC026
SUBARU		
Models with 16mm deep filler neck, see page 9	MPT0007/MPT10128	MPTC007
Models with 9.5mm deep filler neck, see page 9	MPT0008/MPT10138	MPTC008
SUZUKI		
Models with 16mm deep filler neck, see page 9	MPT0007/MPT10128	MPTC007
Models with 9.5mm deep filler neck, see page 9	MPT0008/MPT10138	MPTC008
Foreza 2004-2008	MPT0034/MPT10034P	MPTC246/MPT1 C047P
Reno 2005-2008	MPT0034/MPT10034P	MPTC246/MPT1 C047P
Verona 2004-2006	MPT0034/MPT10034P	MPTC246/MPT1 C047P
XL 7 2007-2009	MPT0036/MPT10036P	MPT1 C037/MPT1 C035P
TOYOTA		
Models with Non-Threaded Cooling System Caps: Models with 16mm deep filler neck, see page 9	MPT0007/MPT10128	MPTC007
Models with 9.5mm deep filler neck, see page 9	MPT0008/MPT10138	MPTC008
Models with Threaded Cooling System Caps: Avalon 2013-current	MPT0048/MPT10048P	MPTC049/MPT1 C049P
Celica 2000-2005	MPT0048/MPT10048P	MPTC049/MPT1 C049P
MR2 Spyder 2000-2005	MPT0048/MPT10048P	MPTC049/MPT1 C049P
RAV 4 1996-2008	MPT0008/MPT10138	MPTC008
2009-current	MPT0048/MPT10048P	MPTC049/MPT1 C049P
Sienna (see page 9) 1998-2006	MPT0007R	MPTC007
2007-current	MPT0008/MPT10138	MPTC008
Hybrid Synergy Drive Cooling System: Camry 2007-current	MPT0048/MPT10048P	MPTC049/MPT1 C049P
Highlander 2006-current	MPT0048/MPT10048P	MPTC049/MPT1 C049P
Prius 2004-current	MPT0048/MPT10048P	MPTC049/MPT1 C049P
TRUCKS/HEAVY DUTY		
Vehicles with large fill ("B") neck (2 11/16") see page 11	A450B/MPT0450 (Kit) or A4505B (Individual Adapter)	A450B/MPT0450 (Kit) or A4504B (Individual Adapter)
VAN HOOL BUS		
Some models	MPT10076	
VOLKSWAGEN		
Models with male threads on filler neck 1975-1993	MPT0022/MPT10022P	MPTC023/MPT1 C023P
Models with female threads on filler neck 2004-current	MPT0041/MPT10041P	MPTC040/MPT1 C040P

Make/Model/Year	Cooling System Adapter	Cap Adapter
VOLKSWAGEN		
Beetle 1998-current	MPT0041/MPT10041P	MPTC040/MPT1 C040P
CC 2009-2019	MPT0041/MPT10041P	MPTC040/MPT1 C040P
Cabrio 1995-2002	MPT0031/MPT10031P	MPTC030
Corrado 1990-1994	MPT0031/MPT10031P	MPTC030
Eurovan 1993-2003	MPT0031/MPT10031P	MPTC030
Golf 1985-1990	MPT0022/MPT10022P	MPTC023/MPT1 C023P
1991-1999	MPT0031/MPT10031P	MPTC030
2000-current	MPT0041/MPT10041P	MPTC040/MPT1 C040P
GTI 1985-1990	MPT0022/MPT10022P	MPTC023/MPT1 C023P
1991-1999	MPT0031/MPT10031P	MPTC030
2000-current	MPT0041/MPT10041P	MPTC040/MPT1 C040P
Jetta 1980-1990	MPT0022/MPT10022P	MPTC023/MPT1 C023P
1991-1999	MPT0031/MPT10031P	MPTC030
1999-current	MPT0041/MPT10041P	MPTC040/MPT1 C040P
Passat 1990-1997	MPT0031/MPT10031P	MPTC030
1998-current	MPT0041/MPT10041P	MPTC040/MPT1 C040P
Phaeton 2002-2016	MPT10074P	MPT1 C023P
Toureg 2004-current	MPT0041/MPT10041P	MPTC040/MPT1 C023P
VOLVO		
All with threaded neck except large trucks and as specified below	MPT0025/MPT10025P	MPTC026/MPT1 C026P
C30 2008-current	MPT0052/MPT10052P	MPTC053/MPT1 C053P
C70 2008-current	MPT0052/MPT10052P	MPTC053/MPT1 C053P
FH 2012-current	MPT0025/MPT10025P	MPTC026/MPT1 C026P
FM 2010-current	MPT0025/MPT10025P	MPTC026/MPT1 C026P
S40 2004-2011	MPT0052/MPT10052P	MPTC053/MPT1 C053P
S80 2004-current	MPT0052/MPT10052P	MPTC053/MPT1 C053P
V50 2005-2011	MPT0052/MPT10052P	MPTC053/MPT1 C053P
V60 2014-current	MPT0052/MPT10052P	MPTC053/MPT1 C053P
V70 2008-2010	MPT0052/MPT10052P	MPTC053/MPT1 C053P
XC60 2010-current	MPT0052/MPT10052P	MPTC053/MPT1 C053P
XC70 2008-current	MPT0052/MPT10052P	MPTC053/MPT1 C053P
Volvo Large Trucks with: • 48mm x 3mm thread • 63mm x 3mm thread	TA50/MPT10022P MPT0027/MPT10027P	MPT1 C023P

MATCO COOLING SYSTEM ADAPTER GASKET APPLICATION GUIDE

(Use gasket part # when ordering replacement gaskets)

ADAPTER

MPT0010, **MPT10084P**
 MPT0034, MPT0036
 MPT0022, MPT0025, TA50, **MPT10034P, MPT10036P**
 MPT0245, **MPT10245P**, MPT0345, **MPT10345P**
 MPT0007, MPT0008, MPT10128, MPT10138
 MPT0031, MPT0041, **MPT10031P, MPT10041P, MPT10074P**
 MPT0036, MPT0046, MPT0052
MPT10046P, MPT10052P, MPT10036P
 MPT0044, **MPT10044P**
 MPT0048, **MPT10048P**
 MPT0027, MPT0054
 MPT0056, **MPT10056P**
 MPT0445, **MPT10445P**
 A4503B
 A450B Kit, A4501B Test Plug (Obsolete)
 MPT0450
MPT10025P
MPT10022P
MPT10027P
MPT10032P
MPT10054P
 MPT0058, **MPT10058P**
 MPT0060
 MPT0063, **MPT10063P, MPT10078P**
 MPT10067, MPT10067R
MPT10069P
MPT10070P
MPT10072P
MPT10076P
MPT10086P

GASKET/O-RING SIZE

2 1/16" O.D. x 1 1/8" I.D. x 1/8" thick
 2 1/16" O.D. x 1 7/16" I.D. x 1/8" thick
 1 7/8" O.D. x 1 3/16" I.D. x 1/8" thick
 1 7/16" O.D. x 15/16" I.D. x 1/16" thick
 1 1/8" O.D. x 1/2" I.D. x 1/4" thick
 36mm O.D. x 28mm I.D. x 4mm cross section O-ring
 31mm O.D. x 23mm I.D. x 4mm cross section O-ring
 31mm O.D. x 23mm I.D. x 4mm cross section O-ring
 42mm O.D. x 34mm I.D. x 4mm cross section O-ring
 13/16" O.D. x 5/8" I.D. x 3/32" cross section O-ring (O-ring # P16)
 2 1/2" O.D. x 1 9/16" I.D. x 1/8" thick
 23mm O.D. x 17mm I.D. x 3mm cross section O-ring
 38mm O.D. x 28mm I.D. x 5mm cross section O-ring
 2 3/4" O.D. x 1 3/4" I.D. x 3/16" thick
 2 1/16" O.D. x 1/2" I.D. x 1/4" thick (2 required)
 Molded Gasket
 1 11/16" O.D. x 1 1/16" I.D. x 1/8" thick
 1 3/4" O.D. x 1" I.D. x 1/8" thick
 2 3/8" O.D. x 1 5/8" I.D. x 1/8" thick
 1 7/8" O.D. x 1 1/16" I.D. x 1/8" thick
 2 1/4" O.D. x 1 1/2" I.D. x 1/8" thick
 27mm O.D. x 21mm I.D. x 3mm cross section O-ring
 Molded Gasket
 1 7/16" O.D. X 1 3/16" I.D. X 1/8" cross section O-ring
 Molded rubber gasket
 1" OD x 5/8" ID x 3/16" thick cross section O-ring
 1" OD x 1/2" ID x 1/16" thick
 19mm OD x 12mm ID x 3.5mm cross section O-ring
 Molded rubber gasket (custom)
 14mm OD x 7mm ID x 3.5mm cross section O-ring

GASKET PART

MPT0010G
 MT0011
 MPT0025G
 MPT0345G
 MT0009
 MPT0031G
 MT0012
 MPT0044G
 MPT0048G
 MPT0027G
 MPT0056G
 MPT0445G
 A4502B
 A4501B1
 MPT0450G
 MPT10025PG
 MPT10022PG
 MPT10027PG
 MPT10032PG
 MPT10054PG
 MPT0058G
 MPT0060G
 MPT0063G
 MPT10067G
 MPT10069R
 MPT10070G
 MPT10072R
 MPT10076G
 MPT10086R



APC102 PARTS LIST

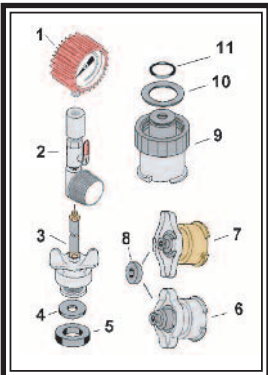
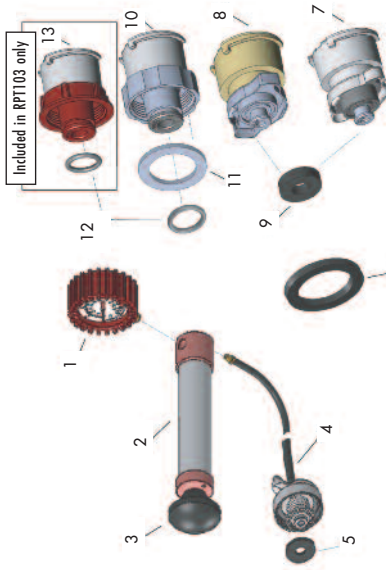

Diagram Number	Stock Part #	Description
NOT SHOWN	MT0000	Plastic Carrying Case, NOT SHOWN
	MPT5001-1	Complete Pump with Gauge and Hose Assy. (1-4)
1	MT0001	Pressure Gauge Only
2	MPT5001-2	Valve Regulator Assembly
3	MPT5001-4	Tester Head with Hose Assembly
4	MT0005	Tester Seal
5	MT0006	Spacer Washer, (1/4" Thick Rubber Washer - see page 9)
6	MPT10128	32 mm x 16mm deep Radiator Adapter with Seal, Silver
7	MPT10138	32 mm x 9.5mm deep Radiator Adapter with Seal, Gold
8	MT0009	Rubber Seal for 32mm Radiator Adapters
9	MPT10036P	Radiator Adapter
10	MPT0025G	Rubber Seal for MPT10036P
11	MT0012	Rubber O-Ring for MPT10036P



Included in RPT103 only

#	Stock #	Description
	MTD005ET	COOLING SYSTEM TESTER PUMP (Diagram #1 through #4)
	MTD000	PLASTIC CARRYING CASE (Not Shown)
1	MTD001	PRESSURE GAUGE ONLY
2	MTD002	PUMP ASSEMBLY WITH KNOB (Gauge not included)
3	MTD003	KNOB ONLY
4	MTD004	TESTER HEAD ASSEMBLY WITH HOSE
		NOTE: Hose is field repairable with 3/16" fuel line.
5	MTD005	TESTER SEAL
6	MTD006	SPACER WASHER (1/4" thick Rubber Washer for 1" deep filler necks see page 9)
7	MPT10128	32 mm x 16 mm Radiator Adapter with Seal (Silver)
8	MPT10138	32 mm x 9.5 mm Radiator Adapter with Seal (Gold)
9	MTD009	RUBBER SEAL for 32mm RADIATOR ADAPTER
10	MPT10036P	RADIATOR ADAPTER (Seal & O-ring included)
11	MPT0025G	RUBBER SEAL for #MPT10036P
12	MTD012	RUBBER O-RING for #MPT10036P and MPT10052P
13	MPT10052P	RADIATOR ADAPTER (Seal & O-ring included Not included in RPT102, but can be ordered)

MCR103A & MCR103U PARTS LIST

MCR103A and MCR103U:

Drawing #	Stock #	Description
*	MCR1020	PLASTIC CARRYING CASE (NOT SHOWN)
1	MCR1031	LOWER CONNECT VACUUM GAUGE
2	MCR1010	COOLANT REFILL BODY SLEEVE
3	MCR1033	COOLANT REFILL VALVE ASSEMBLY
4	MCR1034	COOLANT REFILL HOSE ASSEMBLY
5	MCR1005	INNER VALVE ASSEMBLY
6	MCR1006	AIR INLET VALVE
7	MCR1007	ASSEMBLY SCREWS, 8-32 X 1 1/4" (2 REQ'D)
8	MCR1038	VENTURI BODY
9	MCR1009	OVERFLOW HOSE
15	MCR1034S	COOLANT REFILL SUCTION SCREEN ONLY

MCR103A ONLY:

10	MCR1032A	COOLANT REFILL BODY ASSEMBLY
11	MTD005	TESTER SEAL

MCR103U ONLY:

12	MCR1032U	COOLANT REFILL BODY ASSEMBLY
13	MCR103CS	ADAPTER CONE, STEP (7/16-20 THREAD)
14	MCR103CL	ADAPTER CONE, SMOOTH (7/16-20 THREAD)

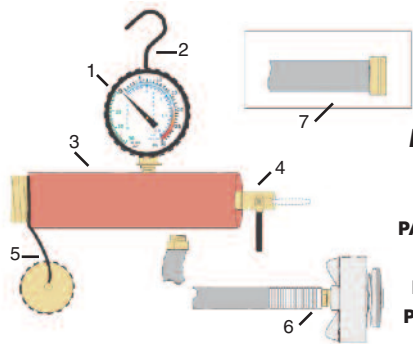

**MPT100CG
COOLANT
GUARD
PARTS DIAGRAM
&
REPLACEMENT
PART NUMBERS**

Number	Part Number	Description
1	MPT100CG-1	Dual Gauge
2	MPT100CG-2	Hook Assembly with Nut
3	MPT100CG-3	Venturi Body
4	MPT100CG-4	Air Inlet Valve
5	MPT100CG-5	Brass GHT cap
6	MPT100CG-6	Intake Hose with Cap Assembly
7	MPT100CG-7	Exhaust Hose
Not Shown	MPT100CG-8	Plastic Box

All non-stocking adapters are available through Matco special order. Use "05" prefix when ordering.

MCR303T

Cooling System Refiller for Large Trucks

Parts Diagram and Part Numbers

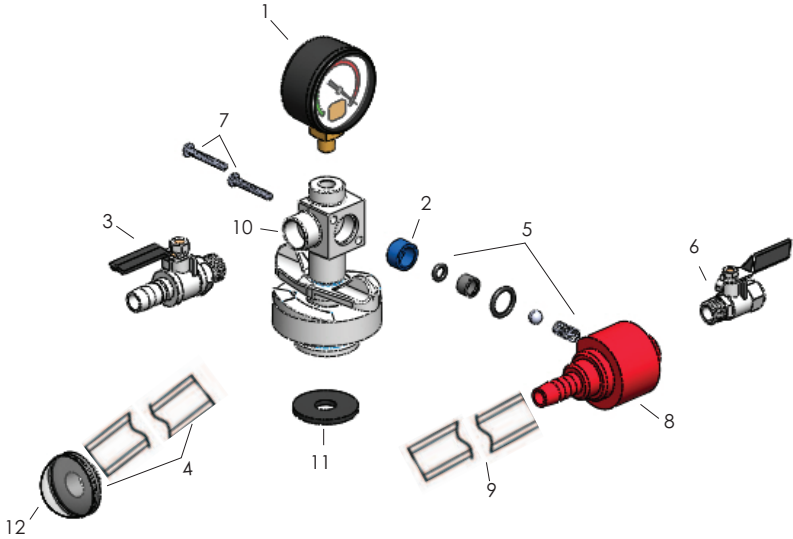

Diagram #	Part #	Description
•	MCR3000	PLASTIC CARRYING CASE (Not Shown)
1	MCR1031	LOWER CONNECT VACUUM GAUGE
2	MCR1010	COOLANT REFILL BODY SLEEVE
3	MCR3031	COOLANT REFILL VALVE ASSY
4	MCR3034	COOLANT REFILL HOSE ASSY
5	MCR1005	INNER VALVE ASSY
6	MCR1006	AIR INLET VALVE
7	MCR1007	ASSEMBLY SCREWS, 8-32 x 1 1/4" (2 REQ'D)
8	MCR3002	VENTURI BODY
9	MCR3033	OVERFLOW HOSE
10	MCR1032A	COOLANT REFILL BODY ASSY
11	MT0005	TESTER SEAL
12	MCR3034S	COOLANT REFILL SUCTION SCREEN ONLY

WARRANTY

The RPT102/RPT103/MCR103A/MCR103U/APC102/MPT100CG/MCR303T is warranted for a period of twelve months from the end user customer's date of purchase against defects in materials and workmanship. Matco, or one of its authorized representatives will, at Matco's option, repair or replace the RPT102/RPT103/MCR103A/MCR103U/APC102/MPT100CG/MCR303T without charge, if the defective or malfunctioning tool is returned to Matco or one of its authorized representatives, shipping prepaid. Please be sure to include your name and address with the tool, and describe the nature of the problem.

Matco shall have no obligation pursuant to the Matco Warranty with respect to tools which in Matco's sole judgment have been altered, damaged, misused, abused or badly worn, lost or improperly maintained. This warranty is null and void if the customer, or any other person other than the authorized representative Matco, has made any attempt to service or modify the tool prior to its return to Matco under this Warranty.

For additional warranty information, contact:

Matco Tools, 4403 Allen Road, Stow, Ohio 44224

©2018 Marvac Scientific. All rights reserved.

FN: MATCO-2018A